

Rozmery v mm  
Maße in mm  
Dimensions in mm

Heat 2g 59.44.13

117kg

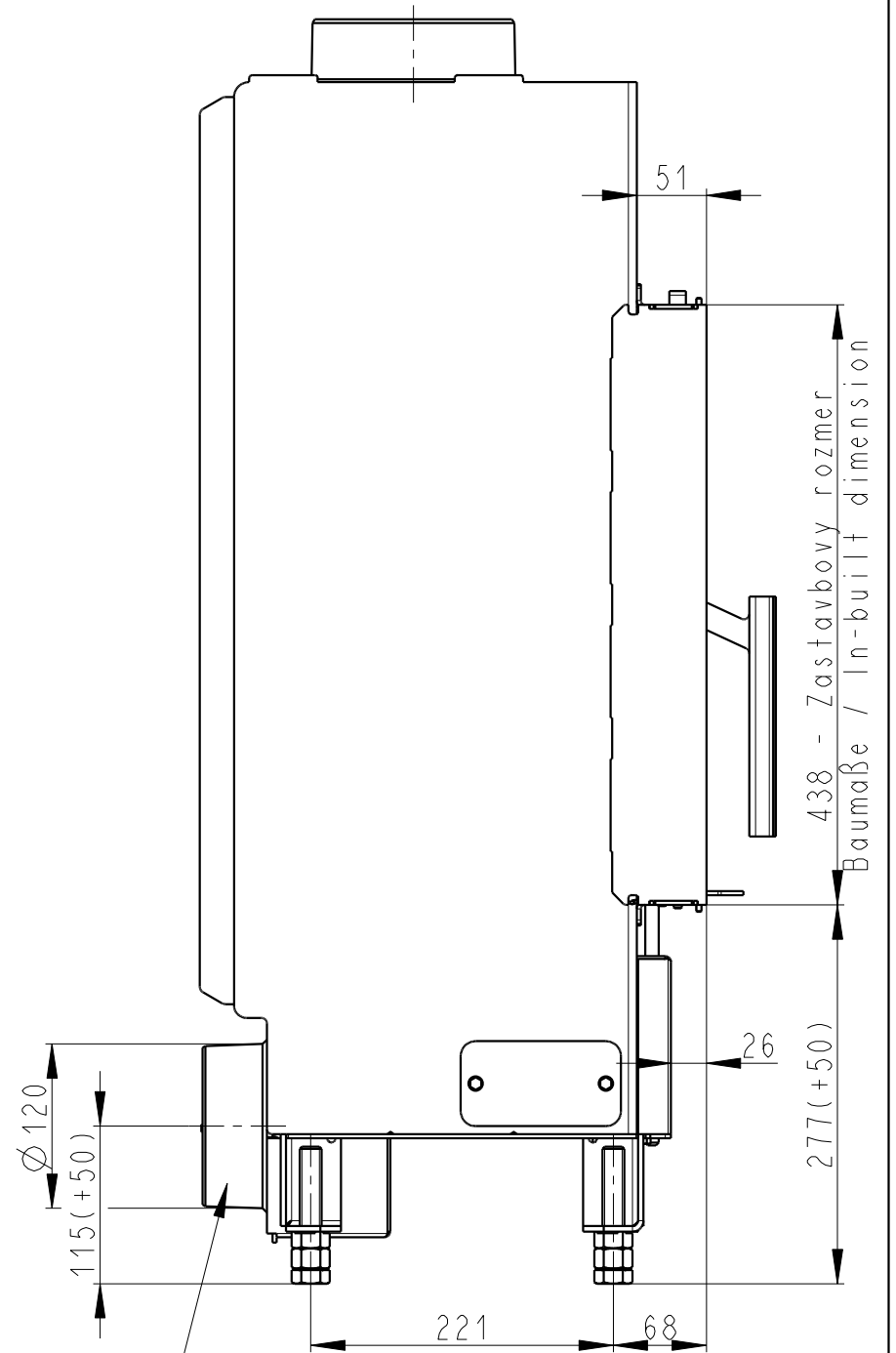
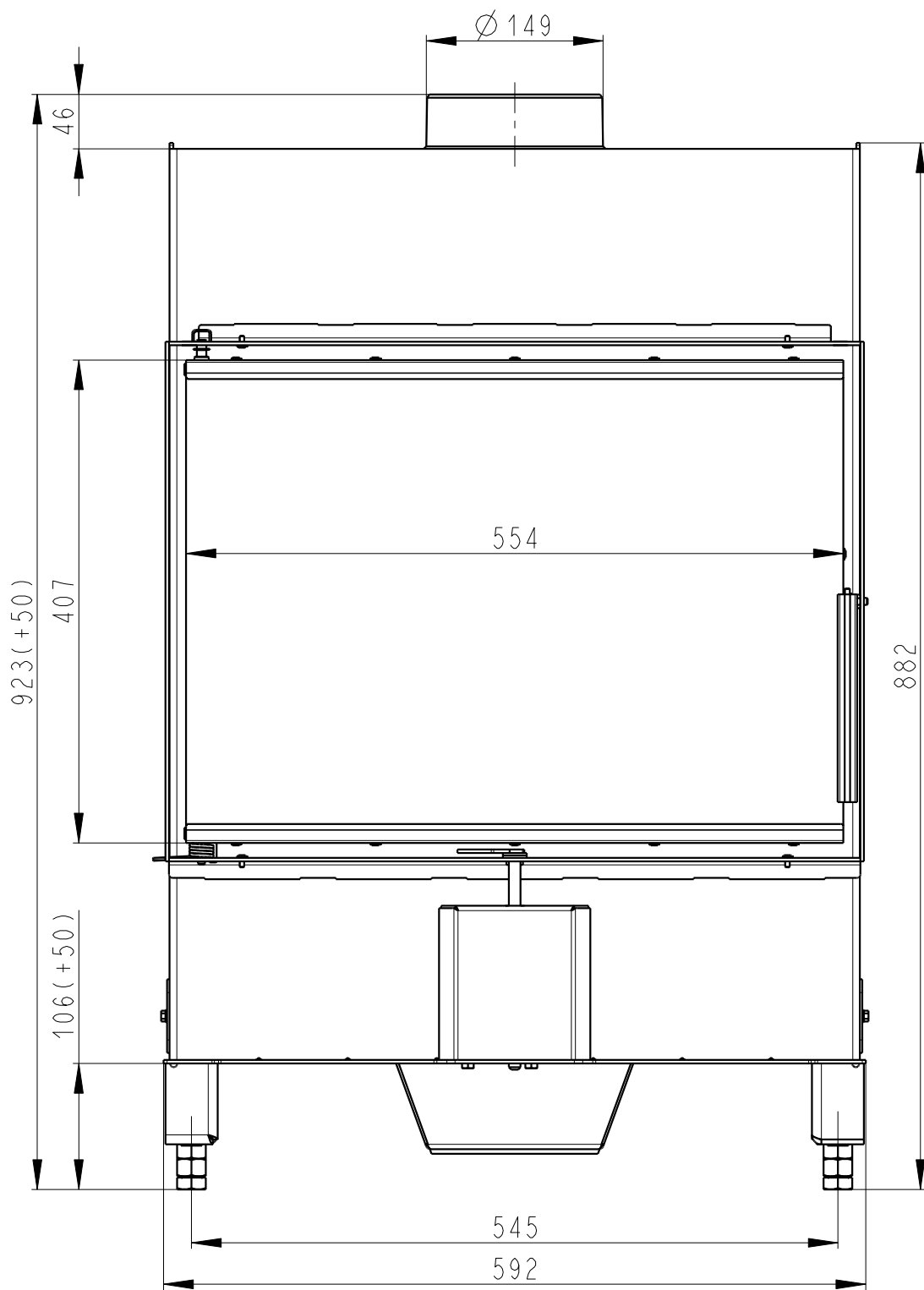

Centralni privod vzduchu  
Central air inlet  
Zentralluftzufuhr

Litinový odvod kouře  
Cast iron spigot  
Der gusseiserne Rauchabgang

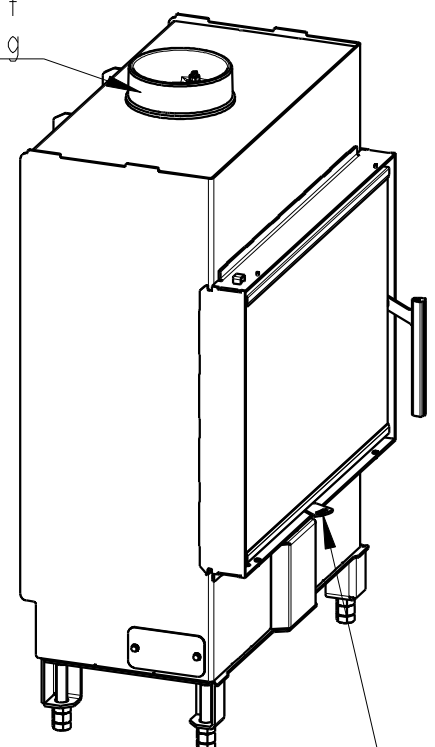
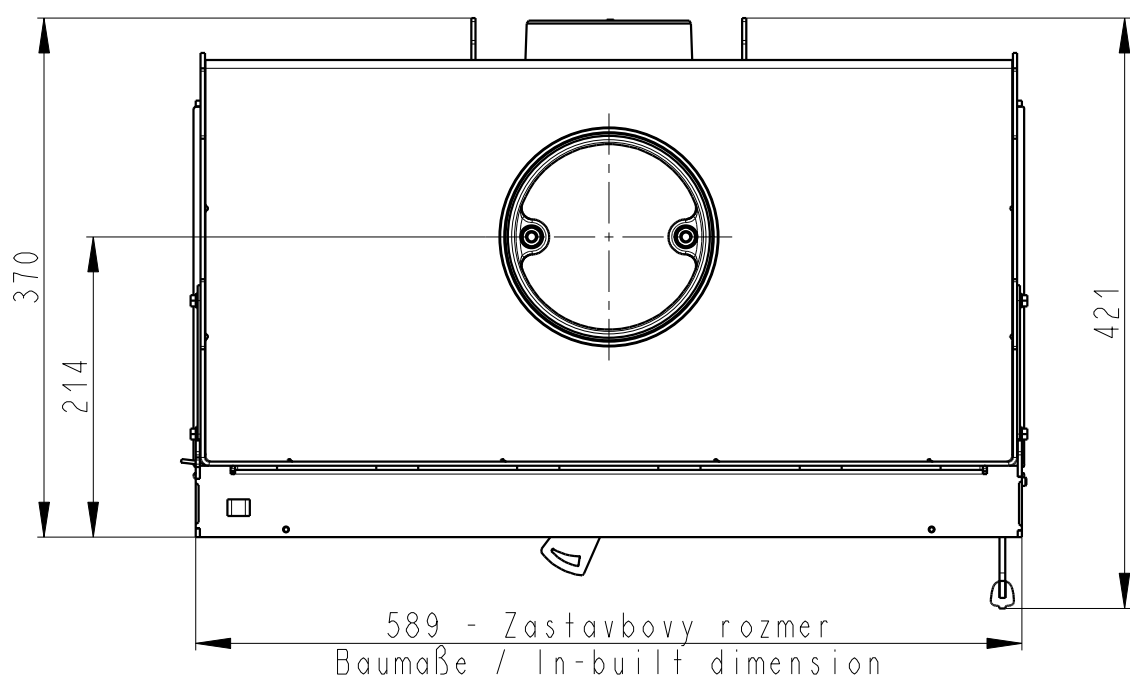

Primarni a sekundarni vzduch  
Primärluft und Sekundärluft  
Primary and secondary air