

A (1:5)

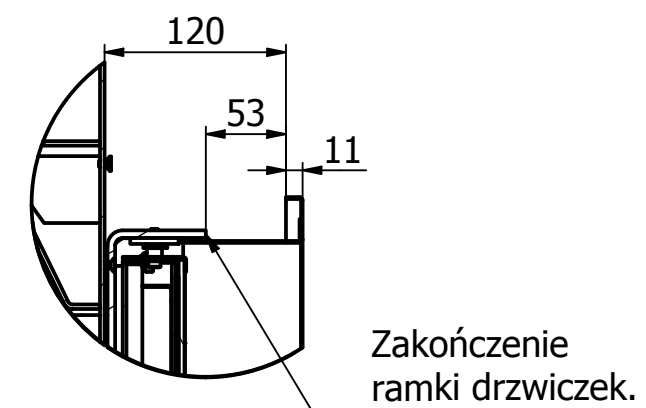

B (1:4)

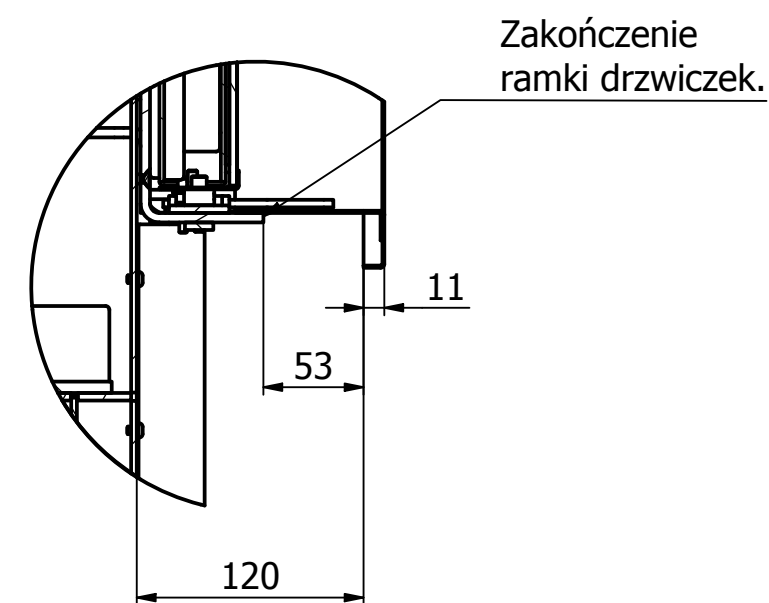

C (1:4)

Możliwość regulacji.

